

	CODICE	DIAMETRO	LUNGHEZZA
Piattaforma 3,75	FIMIEA3310	3,30	10,0
	FIMIEA3311		11,5
	FIMIEA3313		13,0
	FIMIEA3315		15,0
	FIMIEA3708	3,75	8,0
	FIMIEA3710		10,0
	FIMIEA3711		11,5
	FIMIEA3713		13,0
	FIMIEA3715	15,0	
	FIMIEA4206	4,20	6,0
	FIMIEA4208		8,0
	FIMIEA4210		10,0
	FIMIEA4211		11,5
	FIMIEA4213		13,0
	FIMIEA4215	15,0	
	FIMIEA5006	5,00	6,0
	FIMIEA5008		8,0
	FIMIEA5010		10,0
	FIMIEA5011		11,5
FIMIEA5013	13,0		



CODICE	ARTICOLO	PIATTAFORMA
FIMAN37	ANALOGO DA LABORATORIO	3,75
FIMTR37	COPYING DA IMPRONTA (TRANSFER)	
FIMVTR	VITE LUNGA PER COPYNG	
FIMVG372	VITE DI GUARIGIONE H2	
FIMVG373	VITE DI GUARIGIONE H3	
FIMVG374	VITE DI GUARIGIONE H4	
FIMVG375	VITE DI GUARIGIONE H5	
FIMMD37	MONCONE DRITTO	
FIMMDS37	MONCONE DRITTO STRETTO	
FIMMDW37	MONCONE DRITTO WIDE	
FIMMDA372	MONCONE DRITTO ANATOMICO H2	
FIMMDA374	MONCONE DRITTO ANATOMICO H4	
FIMMA1537	MONCONE ANGOLATO 15 GRADI	
FIMMA2537	MONCONE ANGOLATO 25 GRADI	
FIMMPA371	MONCONE A SFERA H1	
FIMMPA372	MONCONE A SFERA H2	
FIMMPA373	MONCONE A SFERA H3	
FIMMPA374	MONCONE A SFERA H4	
FIMMPA375	MONCONE A SFERA H5	
FIMCR37	MONCONE CALCINABILE RUOTANTE	
FIMCN37	MONCONE CALCINABILE NON RUOTANTE	
FIMVP	VITE PASSANTE PROTESICA	
FIMMUD371	MULTI UNIT DRITTO H1	
FIMMUD372	MULTI UNIT DRITTO H2	
FIMMUD373	MULTI UNIT DRITTO H3	
FIMMUD374	MULTI UNIT DRITTO H4	
FIMMUA1737	MULTI UNIT ANGOLATO 17	
FIMMUA3037	MULTI UNIT ANGOLATO 30	
FIMVGM	VITE GUARIGIONE PER MULTI UNIT	
FIMMTM	TORRETTA TITANIO PER MULTI UNIT	
FIMCMU	CALCINABILE PER MULTI UNIT	
FIMAMU	ANALOGO PER MULTI UNIT	
FIMTMU	TRANSFER PER MULTI UNIT	
FIMCMCS	CHIAVETTA DI MONTAGGIO MANUALE CORTA	UNIVERSALE
FIMCMCL	CHIAVETTA DI MONTAGGIO MANUALE LUNGA	
FIMCMMS	CHIAVETTA DI MONTAGGIO CONTR. CORTA	UNIVERSALE
FIMCMML	CHIAVETTA DI MONTAGGIO CONTR. LUNGA	
UNDR127S	DRIVER CORTO 1,27	UNIVERSALE
UNDR127L	DRIVER LUNGO 1,27	
UNDR127LAB	DRIVER LABORATORIO 1,27	
UNCRMA	CRICCHETTO UNIVERSALE	UNIVERSALE
UNCRDI	CRICCHETTO DINAMOMETRICO	



internal
hex

top

cilindrico e conico

piattaforma

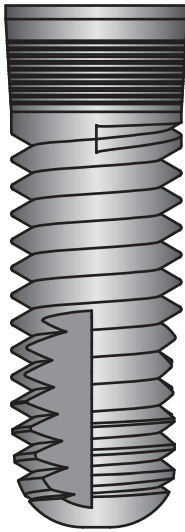

piattaforma

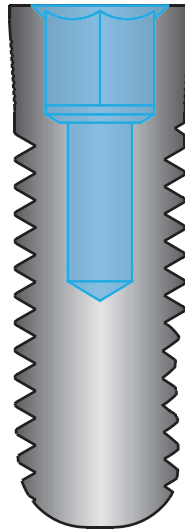

lunghezza

piattaforma

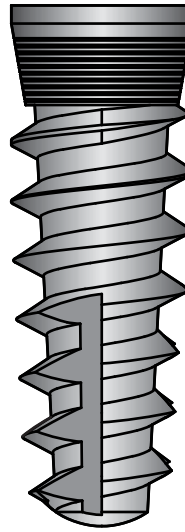

piattaforma

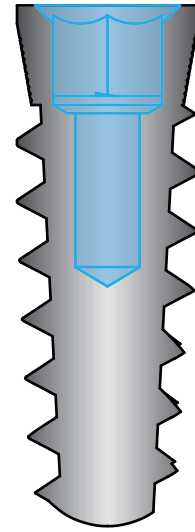

	CODICE	DIAMETRO	LUNGHEZZA
Piattaforma	TOI3308	3,30	8,0
	TOI3310		10,0
	TOI3311		11,5
	TOI3313		13,0
	TOI3316		16,0
	TOI3708		8,0
	TOI3710	10,0	
	TOI3711	3,75	11,5
	TOI3713		13,0
	TOI3716		16,0
	TOI4508	4,50	8,0
	TOI4510		10,0
TOI4511	11,5		
TOI4513	13,0		
TOI4516	16,0		
TOI5508	5,50		8,0
TOI5510		10,0	
TOI5511		11,5	
TOI5513		13,0	
TOI5516		16,0	

	CODICE	DIAMETRO	LUNGHEZZA	
Piattaforma	TOIC4008	4,00	8,0	
	TOIC4010		10,0	
	TOIC4011		11,5	
	TOIC4013		13,0	
	TOIC4016		16,0	
	TOIC5008		8,0	
	TOIC5010	5,00	10,0	
	TOC5011		11,5	
	TOIC5013		13,0	
	TOIC5016		16,0	
	TOIC6008		6,00	8,0
	TOIC6010			10,0
	TOIC6011	11,5		
	TOIC6013	13,0		
	TOIC6016	16,0		

STEIN

STEIN S.r.l.
Via dei Cerri, 2
47899 - Serravalle - RSM

Phone (+378) 0549 960508
Fax (+378) 0549 953759
info@stein.sm www.stein.sm



cilindrico e conico

CODICE	ARTICOLO	PIATTAFORMA
TOAN35	ANALOGO DA LABORATORIO	3,5
TOAN40		4,0
TOAN50		5,0
TOAN60		6,0
TOTR35	COPYING DA IMPRONTA (TRANSFER)	3,5
TOTR40		4,0
TOTR50		5,0
TOTR60		6,0
TOVTR	VITE PASSANTE LUNGA COPYING	TUTTI
TOVG351	VITE DI GUARIGIONE altezza 1 mm	3,5
TOVG401		4,0
TOVG501		5,0
TOVG601		6,0
TOVG352	VITE DI GUARIGIONE altezza 2 mm	3,5
TOVG402		4,0
TOVG502		5,0
TOVG602		6,0
TOVG353	VITE DI GUARIGIONE altezza 3 mm	3,5
TOVG403		4,0
TOVG503		5,0
TOVG603		6,0
TOMP35	MONCONE PROVVISORIO PEEK	3,5
TOMP40		4,0
TOMP50		5,0
TOMP60		6,0
TOMD35	MONCONE IN TITANIO DRITTO	3,5
TOMD40		4,0
TOMD50		5,0
TOMD60		6,0
TOMA1533	MONCONE IN TITANIO ANGOLATO 15 GRADI	3,5
TOMA1540		4,0
TOMA1550		5,0
TOMA1560		6,0
TOMA2533	MONCONE IN TITANIO ANGOLATO 25 GRADI	3,5
TOMA2540		4,0
TOMA2550		5,0
TOMA2560		6,0
TOCN35	MONCONE CALCINABILE	3,5
TOCN40		4,0
TOCN50		5,0
TOCN60		6,0
TOCR35	MONCONE CALCINABILE ROTANTE	3,5
TOCR40		4,0
TOCR50		5,0
TOCR60		6,0
TOVP	VITE PASSANTE PROTESICA 1,3 M1,8	TUTTI
TOVPC	VITE PASSANTE PROTESICA 1,3 M1,8 CONICA	TUTTI
TOCMMS	CHIAVE MONTAGGIO MANUALE CORTA	UNIVERSALE
TOCMML	CHIAVE DI MONTAGGIO MANUALE LUNGA	
TOCMCS	CHIAVETTA DI MONTAGGIO CONTRANGOLO CORTA	UNIVERSALE
TOCMCL	CHIAVETTA DI MONTAGGIO CONTRANGOLO LUNGA	
UNDR127S	DRIVER 1,27 CORTO	UNIVERSALE
UNDR127L	DRIVER 1,27 LUNGO	
UNDR127LAB	DRIVER 1,27 LABORATORIO	
UNCRMA	CRICCHETTO UNIVERSALE	UNIVERSALE
UNCRDI	CRICCHETTO DINAMOMETRICO	



external
hex

perfect

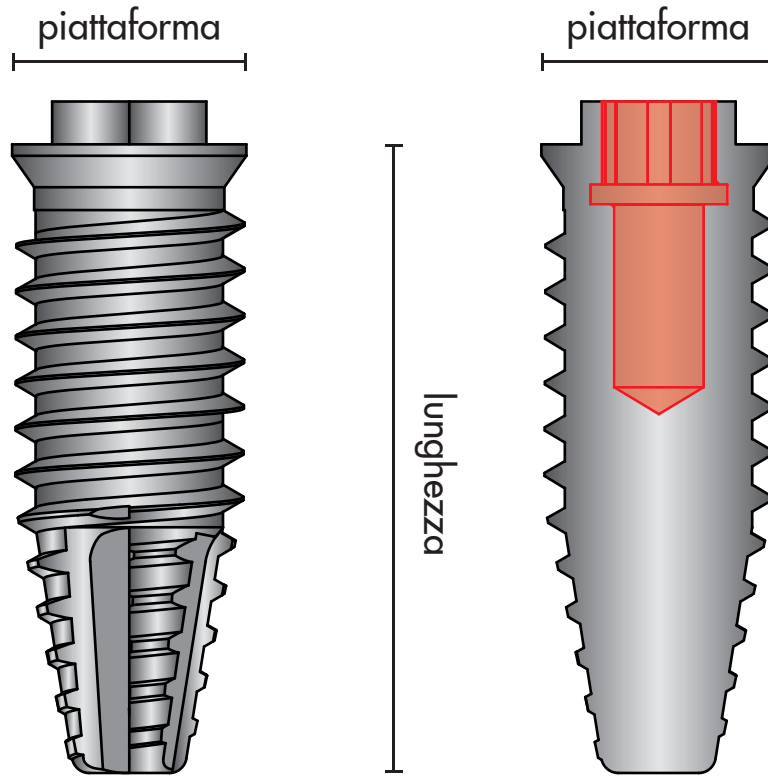

		CODICE	DIAMETRO	LUNGHEZZA	
Piattaforma	4,1	PEI3308	3,30	8,0	
		PEI3310		10,0	
		PEI3311		11,5	
		PEI3313		13,0	
		PEI3708		3,75	8,0
		PEI3710			10,0
	PEI3711	11,5			
	PEI3713	13,0			
	PEI4008	4,00	8,0		
	PEI4010		10,0		
	PEI4011		11,5		
	PEI4013		13,0		
5,0		5,00	8,0		
			10,0		
			11,5		
			13,0		

STEIN

STEIN S.r.l.
Via dei Cerri, 2
47899 - Serravalle - RSM

Phone (+378) 0549 960508
Fax (+378) 0549 953759
info@stein.sm www.stein.sm



CODICE	ARTICOLO	PIATTAFORMA
PEAN41	ANALOGO DA LABORATORIO	4,1
PEAN50		5
PETR41	COPYING DA IMPRONTA (TRANSFER)	4,1
PETR50		5
PEVTR	VITE LUNGA PER COPYNG	TUTTE
PEVG412	VITE DI GUARIGIONE altezza 2 mm	4,1
PEVG502		5
PEVG413	VITE DI GUARIGIONE altezza 3 mm	4,1
PEVG503		5
PEVG414	VITE DI GUARIGIONE altezza 4 mm	4,1
PEVG504		5
PEVG415	VITE DI GUARIGIONE altezza 5 mm	4,1
PEVG505		5
PEMD411	MONCONE IN TITANIO DRITTO altezza 1	4,1
PEMD501		5
PEMD412	MONCONE IN TITANIO DRITTO altezza 2	4,1
PEMD502		5
PEMD413	MONCONE IN TITANIO DRITTO altezza 3	4,1
PEMD503		5
PEMDW41	MONCONE DRITTO WIDE (FRESABILE)	4,1
PEMDW50		5
PEMA1541	MONCONE IN TITANIO ANGOLATO 15 GRADI	4,1
PEMA1550		5
PEMA2541	MONCONE IN TITANIO ANGOLATO 25 GRADI	4,1
PEMA2550		5
PECN41	MONCONE CALCINABILE	4,1
PECN50		5
PECR41	MONCONE CALCINABILE ROTANTE	4,1
PECR50		5
PEVP	VITE PASSANTE PROTESICA 1,2	TUTTE
PECMC	CHIAVETTA DI MONTAGGIO MANUALE CORTA	UNIVERSALE
PECMML	CHIAVETTA DI MONTAGGIO MANUALE LUNGA	
PECMCC	CHIAVETTA DI MONTAGGIO CONTRANGOLO CORTA	UNIVERSALE
PECMCL	CHIAVETTA DI MONTAGGIO CONTRANGOLO LUNGA	
UNDR120C	DRIVER 1,20 CORTO	UNIVERSALE
UNDR120L	DRIVER 1,20 LUNGO	
UNDR120LAB	DRIVER 1,20 LABORATORIO	
UNCRMA	CRICCHETTO UNIVERSALE	UNIVERSALE
UNCRDI	CRICCHETTO DINAMOMETRICO	

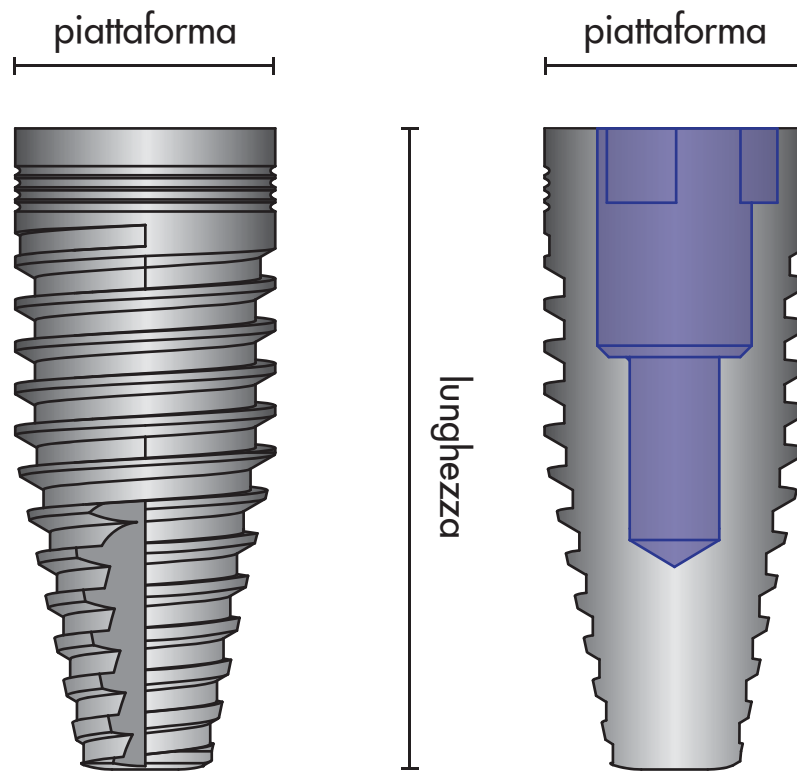

	CODICE	DIAMETRO	LUNGHEZZA
Piattaforma	RPLI3508	3,50	8,0
	RPLI3510		10,0
	RPLI3513		13,0
	RPLI3516		16,0
	RPLI4308	4,30	8,0
	RPLI4310		10,0
	RPLI4313		13,0
	RPLI4316		16,0
	RPLI5008	5,00	8,0
	RPLI5010		10,0
	RPLI5013		13,0
	RPLI5016		16,0
RPLI6008	6,00	8,0	
RPLI6010		10,0	
RPLI6013		13,0	
RPLI6016		16,0	



CODICE	ARTICOLO	PIATTAFORMA
RPLAN35	ANALOGO DA LABORATORIO	3,5
RPLAN43		4,3
RPLAN50		5,0
RPLAN60		6,0
RPLTR35	COPYING DA IMPRONTA (TRANSFER)	3,5
RPLTR43		4,3
RPLTR50		5,0
RPLTR60		6,0
RPLVT18	VITE PASSANTE COPYING m 1,8	3,5
RPLVT20	VITE PASSANTE COPYING m 2,0	TUTTE (tranne 3,5)
RPLVG353	VITE DI GUARIGIONE altezza 3 mm	3,5
RPLVG433		4,3
RPLVG503		5,0
RPLVG603		6,0
RPLVG355	VITE DI GUARIGIONE altezza 5 mm	3,5
RPLVG435		4,3
RPLVG505		5,0
RPLVG605		6,0
RPLMD351	MONCONE IN TITANIO DRITTO altezza 1	3,5
RPLMD431		4,3
RPLMD501		5,0
RPLMD601		6,0
RPLMD352	MONCONE IN TITANIO DRITTO altezza 2	3,5
RPLMD432		4,3
RPLMD502		5,0
RPLMD602		6,0
RPLMD353	MONCONE IN TITANIO DRITTO altezza 3	3,5
RPLMD433		4,3
RPLMD503		5,0
RPLMD603		6,0
RPLMD354	MONCONE IN TITANIO DRITTO altezza 4	3,5
RPLMD434		4,3
RPLMD504		5,0
RPLMD604		6,0
RPLMA1535	MONCONE IN TITANIO ANGOLATO 15 GRADI	3,5
RPLMA1543		4,3
RPLMA1550		5,0
RPLMA1560		6,0
RPLMA2535	MONCONE IN TITANIO ANGOLATO 25 GRADI	3,5
RPLMA2543		4,3
RPLMA2550		5,0
RPLMA2560		6,0
RPLCN35	MONCONE CALCINABILE NON RUOTANTE	3,5
RPLCN43		4,3
RPLCN50		5,0
RPLCN60		6,0
RPLCR35	MONCONE CALCINABILE RUOTANTE	3,5
RPLCR43		4,3
RPLCR50		5,0
RPLCR60		6,0
RPLVP18	VITE PASSANTE PROTESICA 1,2 M1,8	3,5
RPLVP20	VITE PASSANTE PROTESICA 1,2 M2,0	TUTTE (tranne 3,5)
RPLCMMS	CHIAVETTA DI MONTAGGIO MANUALE CORTA	TUTTE
RPLCMML	CHIAVETTA DI MONTAGGIO MANUALE LUNGA	
RPLCMCS	CHIAVETTA DI MONTAGGIO CONTR. CORTA	TUTTE
RPLCMCL	CHIAVETTA DI MONTAGGIO CONTR. LUNGA	
UNDRTXS	DRIVER CORTO TORX	UNIVERSALE
UNDRTXL	DRIVER LUNGO TORX	
UNDRTXLAB	DRIVER LABORATORIO TORX	UNIVERSALE
UNCRMA	CRICCHETTO MANUALE	



conical
octagon

octa

std

sp

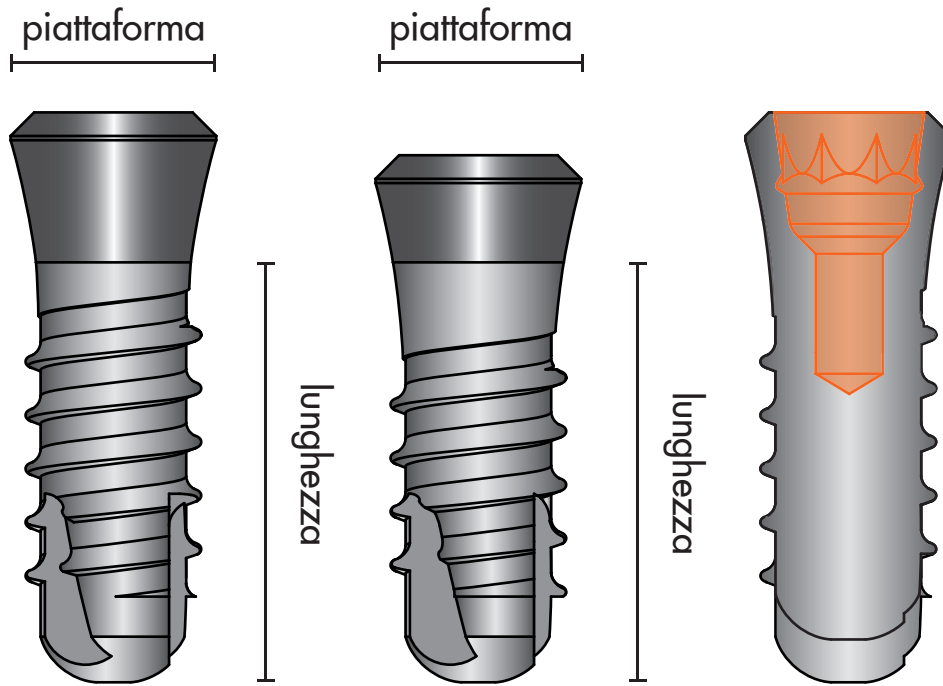

Piattaforma 4,8	CODICE	DIAMETRO	LUNGHEZZA
	OCTIR3308	3,30	8,0
	OCTIR3310		10,0
	OCTIR3312		12,0
	OCTIR3314		14,0
	OCTIR3316	16,0	
	OCTIR4106	4,10	6,0
	OCTIR4108		8,0
	OCTIR4110		10,0
	OCTIR4112		12,0
	OCTIR4114	14,0	
	OCTIR4116	16,0	
	OCTIR4806	4,80	6,0
	OCTIR4808		8,0
	OCTIR4810		10,0
	OCTIR4812		12,0
OCTIR4814	14,0		

Piattaforma 4,8	CODICE	DIAMETRO	LUNGHEZZA
	OCTISPR3308	3,30	8,0
	OCTISPR3310		10,0
	OCTISPR3312		12,0
	OCTISPR3314		14,0
	OCTISPR3316	16,0	
	OCTISPR4106	4,10	6,0
	OCTISPR4108		8,0
	OCTISPR4110		10,0
	OCTISPR4112		12,0
	OCTISPR4114	14,0	
	OCTISPR4116	16,0	
	OCTISPR4806	4,80	6,0
	OCTISPR4808		8,0
	OCTISPR4810		10,0
	OCTISPR4812		12,0
OCTISPR4814	14,0		

STEIN

STEIN S.r.l.
Via dei Cerri, 2
47899 - Serravalle - RSM

Phone (+378) 0549 960508
Fax (+378) 0549 953759
info@stein.sm www.stein.sm



CODICE	ARTICOLO	PIATTAFORMA	
OCTAN48	ANALOGO DA LAB.	4,8	
OCTTRPU48	TRANSFER PICK UP		
OCTTRPI48	TRANSFER POP IN		
OCTVTR	VITE LUNGA PER TRANSFER		
OCTVG481	VITE GUAR. ALTEZZA 1,5		
OCTVG482	VITE GUAR. ALTEZZA 2		
OCTVG483	VITE GUAR. ALTEZZA 3		
OCTMD48	MONCONE IN TITANIO DRITTO		
OCTMA1548	MONCONE ANGOLATO 15		
OCTMA2048	MONCONE ANGOLATO 20		
OCTVP	VITE PASSANTE PROTESICA		
OCTMPA481	MONCONE A SFERA H1		
OCTMPA482	MONCONE A SFERA H2		
OCTMPA483	MONCONE A SFERA H3		
OCTCN48	CALCINABILE		
OCTCR48	CALCINABILE ROTANTE		
OCTSY48	SYNOCTA		
OCTCSR48	CALCINABILE SYNOCTA ROTANTE		
OCTCSN48	CALCINABILE SYNOCTA NON ROTANTE		
OCTMP4840	MONCONE PIENO H. 4,0		
OCTMP4855	MONCONE PIENO H. 5,5		
OCTMP4870	MONCONE PIENO H. 7,0		
OCTANMP4840	ANALOGO MONCONE PIENO H. 4,0		
OCTANMP4855	ANALOGO MONCONE PIENO H. 5,5		
OCTANMP4870	ANALOGO MONCONE PIENO H. 7,0		
STRCMMSH	CHIAVETTA DI MONTAGGIO MANUALE CORTA		TUTTE
STRCMMLO	CHIAVETTA DI MONTAGGIO MANUALE LUNGA		
STRCMC	CHIAVETTA DI MONTAGGIO CONTRANGOLO		
UNDRSTSH	DRIVER CORTO	UNIVERSALE	
UNDRSTLO	DRIVER LUNGO		
UNDRSTLAB	DRIVER LABORATORIO		
UNCRMA	CRICCHETTO MANUALE		
UNCRDI	CRICCHETTO DINAMOMETRICO		



conical
hex

act

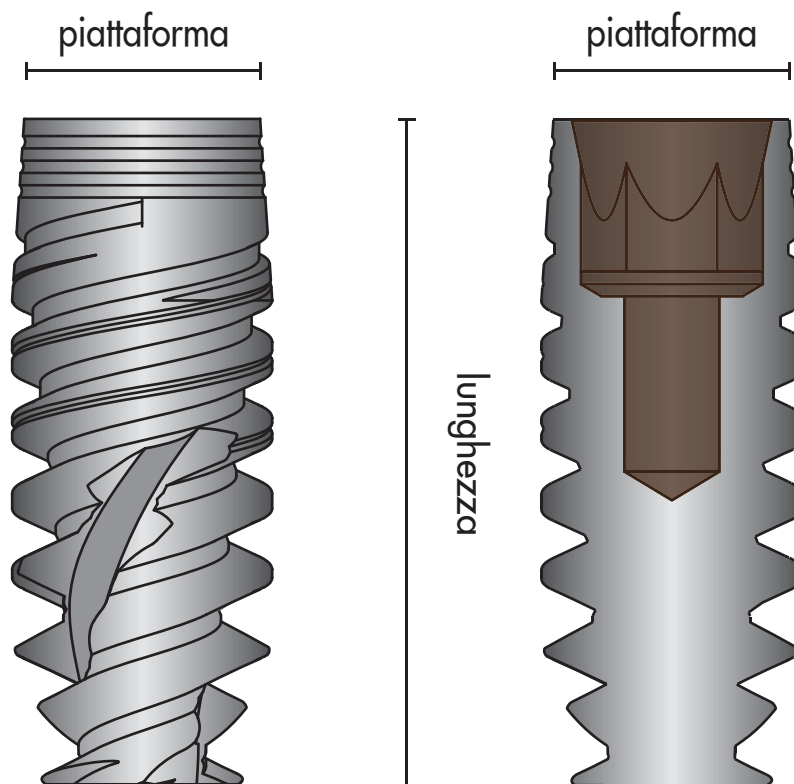

	CODICE	DIAMETRO	LUNGHEZZA
Piattaforma 3,5	ACTI3508	3,50	8,5
	ACTI3510		10,0
	ACTI3511		11,5
	ACTI3513		13,0
	ACTI3515		15,0
	ACTI3518		18,0
Piattaforma 4,3	ACTI4308	4,30	8,5
	ACTI4310		10,0
	ACTI4311		11,5
	ACTI4313		13,0
	ACTI4315		15,0
	ACTI4318		18,0
Piattaforma 5,0	ACTI5008	5,00	8,5
	ACTI5010		10,0
	ACTI5011		11,5
	ACTI5013		13,0
	ACTI5015		15,0
	ACTI5018		18,0

STEIN

STEIN S.r.l.
Via dei Cerri, 2
47899 - Serravalle - RSM

Phone (+378) 0549 960508
Fax (+378) 0549 953759
info@stein.sm www.stein.sm



CODICE	ARTICOLO	PIATTAFORMA
ACTAN35	ANALOGO DA LABORATORIO	3,5
ACTAN43		4,3
ACTTR35	COPYING DA IMPRONTA (TRANSFER)	3,5
ACTTR43		4,3
ACTVT18	VITE PASSANTE COPYING m 1,8	3,5
ACTVT20	VITE PASSANTE COPYING m 2,0	4,3
ACTVG353	VITE DI GUARIGIONE altezza 3 mm	3,5
ACTVG433		4,3
ACTVG355	VITE DI GUARIGIONE altezza 5 mm	3,5
ACTVG435		4,3
ACTMD351	MONCONE IN TITANIO DRITTO	3,5
ACTMD431		4,3
ACTMA1535	MONCONE IN TITANIO ANGOLATO 15 GRADI	3,5
ACTMA1543		4,3
ACTMA2535	MONCONE IN TITANIO ANGOLATO 25 GRADI	3,5
ACTMA2543		4,3
ACTCN35	MONCONE CALCINABILE NON RUOTANTE	3,5
ACTCN43		4,3
ACTCR35	MONCONE CALCINABILE RUOTANTE	3,5
ACTCR43		4,3
ACTVP18	VITE PASSANTE PROTESICA 1,2 M1,8	3,5
ACTVP20	VITE PASSANTE PROTESICA 1,2 M2,0	4,3
ACTMUD351	MULTI UNIT DRITTO H1	3,5
ACTMUD431	MULTI UNIT DRITTO H1	4,3
ACTMUD352	MULTI UNIT DRITTO H2	3,5
ACTMUD432	MULTI UNIT DRITTO H2	4,3
ACTMUD353	MULTI UNIT DRITTO H3	3,5
ACTMUD433	MULTI UNIT DRITTO H3	4,3
ACTMUD354	MULTI UNIT DRITTO H4	3,5
ACTMUD434	MULTI UNIT DRITTO H4	4,3
ACTMUA1735	MULTI UNIT ANGOLATO 17	3,5
ACTMUA1743	MULTI UNIT ANGOLATO 17	4,3
ACTMUA3035	MULTI UNIT ANGOLATO 30	3,5
ACTMUA3043	MULTI UNIT ANGOLATO 30	4,3
ACTVGM	VITE GUARIGIONE PER MULTI UNIT	TUTTE
ACTMTM	TORRETTA TITANIO PER MULTI UNIT	
ACTCMU	CALCINABILE PER MULTI UNIT	
ACTAMU	ANALOGO PER MULTI UNIT	
ACTTMU	TRANSFER PER MULTI UNIT	TUTTE
ACTCMMS	CHIAVETTA DI MONTAGGIO MANUALE CORTA	
ACTCMML	CHIAVETTA DI MONTAGGIO MANUALE LUNGA	TUTTE
ACTCMCS	CHIAVETTA DI MONTAGGIO CONTR. CORTA	
ACTCMCL	CHIAVETTA DI MONTAGGIO CONTR. LUNGA	UNIVERSALE
UNDRTXS	DRIVER CORTO TORX	
UNDRTXL	DRIVER LUNGO TORX	
UNDRTXLAB	DRIVER LABORATORIO TORX	
UNCRMA	CRICCHETTO MANUALE	UNIVERSALE

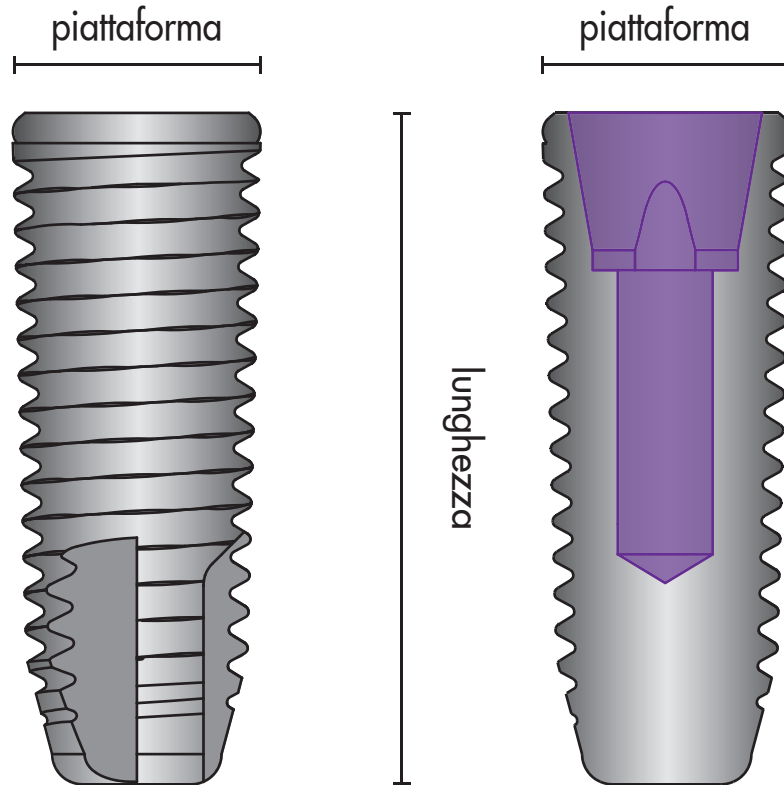

	CODICE	DIAMETRO	LUNGHEZZA	
Piattaforma 3,5	MGIPC3307	3,30	7,0	
	MGIPC3308		8,5	
	MGIPC3310		10,0	
	MGIPC3311		11,5	
	MGIPC3313		13,0	
	Piattaforma 4,0	MGIPC4007	4,00	7,0
		MGIPC4008		8,5
		MGIPC4010		10,0
		MGIPC4011		11,5
		MGIPC4013		13,0
		MGIPC4507	4,50	7,0
		MGIPC4508		8,5
		MGIPC4510		10,0
MGIPC4511		11,5		
MGIPC4513		13,0		
Piattaforma 5,0	MGIPC5007	5,00	7,0	
	MGIPC5008		8,5	
	MGIPC5010		10,0	
	MGIPC5011		11,5	
	MGIPC5013		13,0	



CODICE	ARTICOLO	PIATTAFORMA
MGAN33	ANALOGO DA LABORATORIO	3,5
MGAN40		4,3
MGTR33	COPYING DA IMPRONTA (TRANSFER)	3,5
MGTR40		4,3
MGVT16	VITE PASSANTE COPYING m 1,8	3,5
MGVT20	VITE PASSANTE COPYING m 2,0	4,3
MGVG333	VITE DI GUARIGIONE altezza 3 mm	3,5
MGVG403		4,3
MGVG335	VITE DI GUARIGIONE altezza 5 mm	3,5
MGVG405		4,3
MGVG337	VITE DI GUARIGIONE altezza 7 mm	3,5
MGVG407		4,3
MGMD33	MONCONE IN TITANIO DRITTO D.3,3	3,5
MGMD405	MONCONE IN TITANIO DRITTO D.4,0 PROFILO D.5	4,3
MGMD406	MONCONE IN TITANIO DRITTO D.4,0 PROFILO D.6	
MGMA1533	MONCONE IN TITANIO ANGOLATO 15 GRADI	3,5
MGMA1540	MONCONE IN TITANIO ANGOLATO 15 GRADI	4,3
MGVP16	VITE PASSANTE PROTESICA 1,2 M1,8	3,5
MGVP20	VITE PASSANTE PROTESICA 1,2 M2,0	4,3
MGMOC332	MONCONE OCTA H.2	3,5
MGMOC402		4,3
MGMOC333	MONCONE OCTA H.3	3,5
MGMOC403		4,3
MGMOC334	MONCONE OCTA H.4	3,5
MGMOC404		4,3
MGOCT	TORRETTA PER OCTA	TUTTE
MGVPO	VITE PASSANTE TORRETTA OCTA	
MGANO	ANALOGO PER OCTA	
MGVGO	VITE DI GUARIGIONE PER OCTA	
MGCMMS	CHIAVETTA DI MONTAGGIO MANUALE CORTA	TUTTE
MGCMML	CHIAVETTA DI MONTAGGIO MANUALE LUNGA	
MGCMCS	CHIAVETTA DI MONTAGGIO CONTR. CORTA	
MGCMCL	CHIAVETTA DI MONTAGGIO CONTR. LUNGA	
UNDRTXS	DRIVER CORTO TORX	UNIVERSALE
UNDRTXL	DRIVER LUNGO TORX	UNIVERSALE
UNDRTXLAB	DRIVER LABORATORIO TORX	
UNCRMA	CRICCHETTO MANUALE	